

CURTICE STREET RESIDENCES
WEST BUILDING – DARK PACKAGE



ESTD / 1999

KIM LAYNE

interiors

Single panel interior doors
painted gray



Door Hardware



INTERIOR FINISHES

Hardwoods
Site finished white oak



Carpet



Base + case
SW7005 Pure White

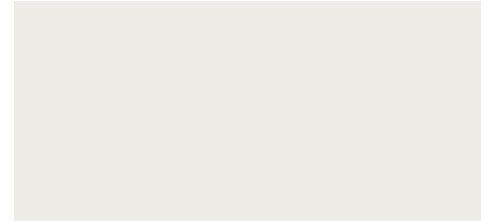

Walls
SW7004 Snowbound

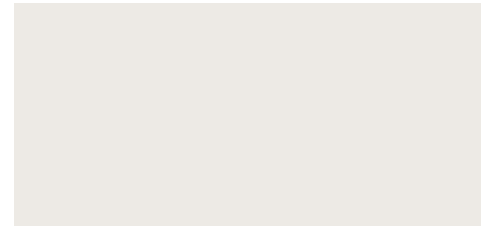

Doors
SW7016 Mindful Gray



ESTD / 1999

KIM LAYNE

interiors

CONCEPTUAL IMAGES

Powder Bath Wainscoting



Master Bedroom Accent Wall



Powder wainscoting +
Master accent wall
SW7018 Dovetail

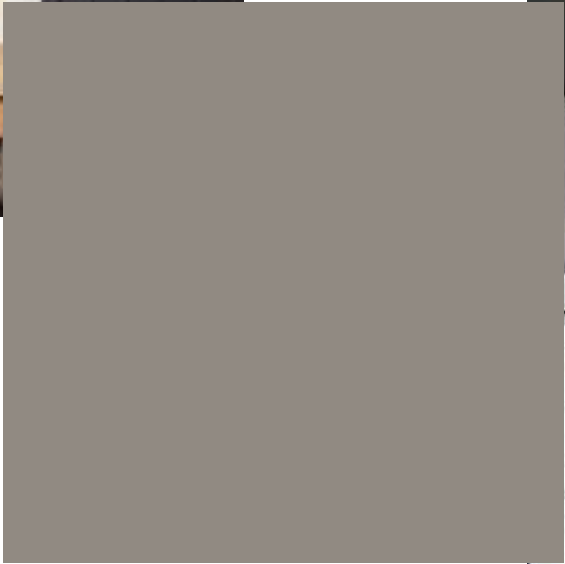

ESTD / 1999

KIM LAYNE

interiors

KITCHEN

Backsplash

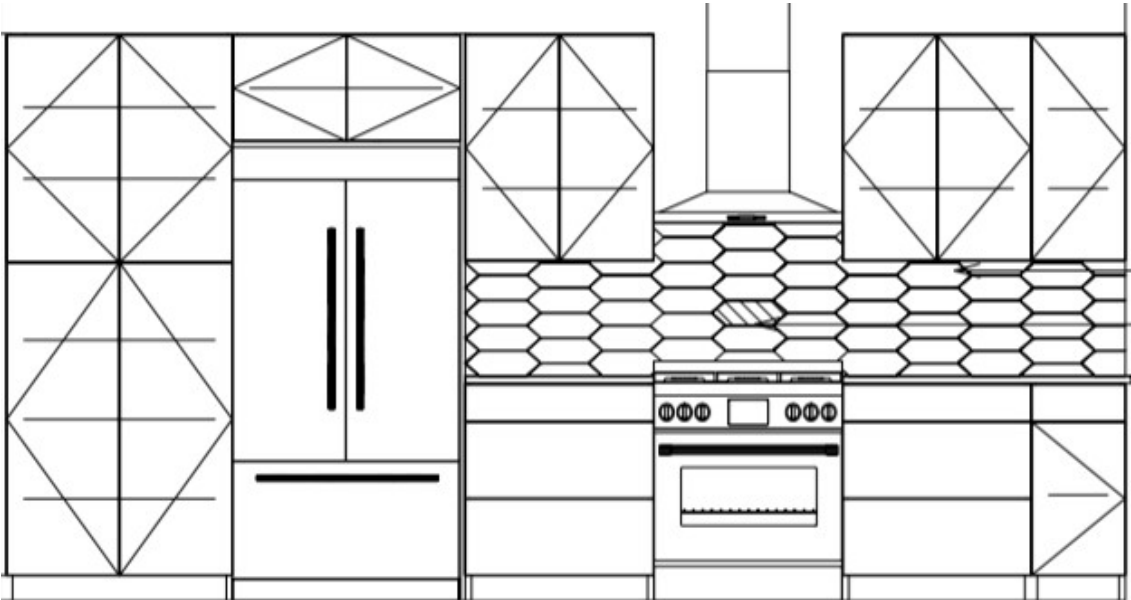
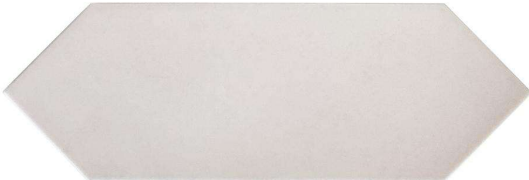

Kitchen Pendants



Cabinetry

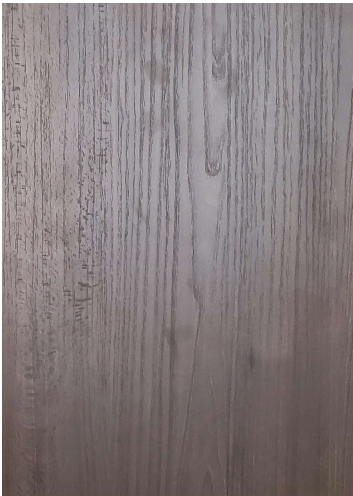

Dining Light



ESTD / 1999

KIM LAYNE

interiors

OWNER'S ENTRY + POWDER BATH

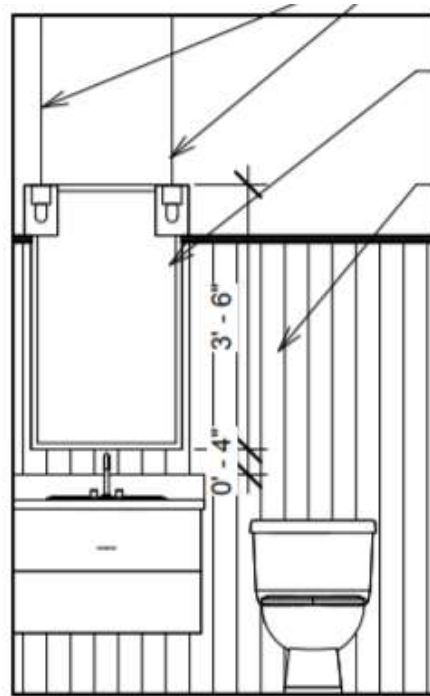
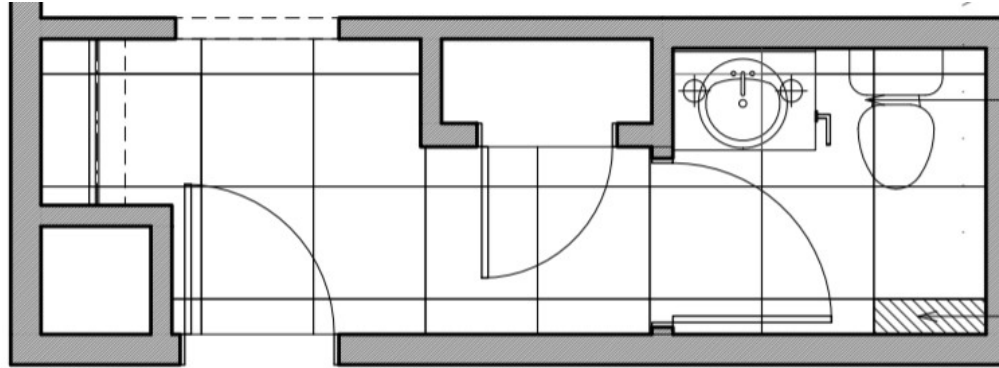

Cabinetry

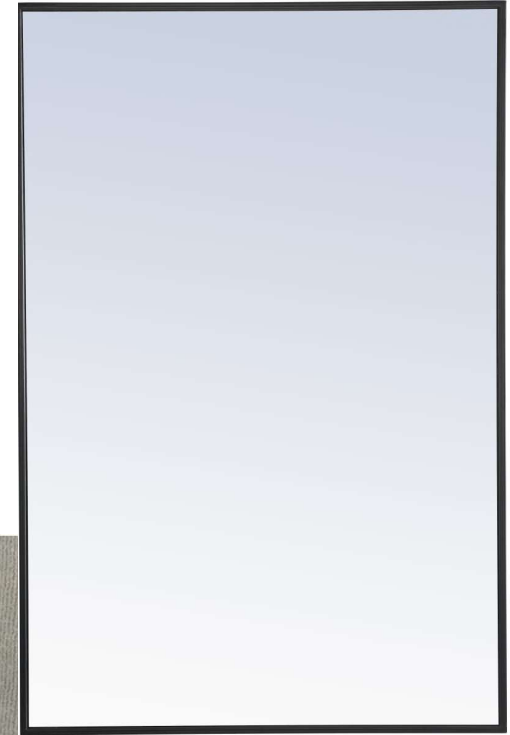

ESTD / 1999

KIM LAYNE

interiors

MASTER BATH

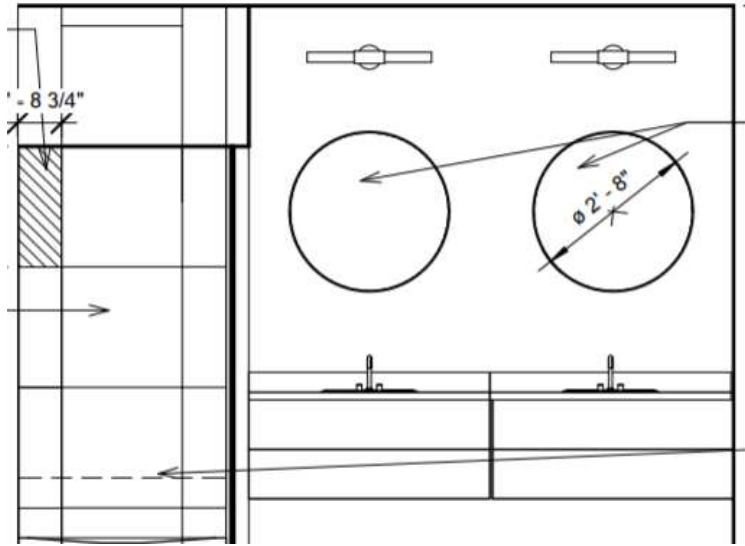

Floors + Shower Back Wall



Shower Side Walls 24x24, straight set



Shower Floor 2x2 mosaic



32" round black metal mirrors

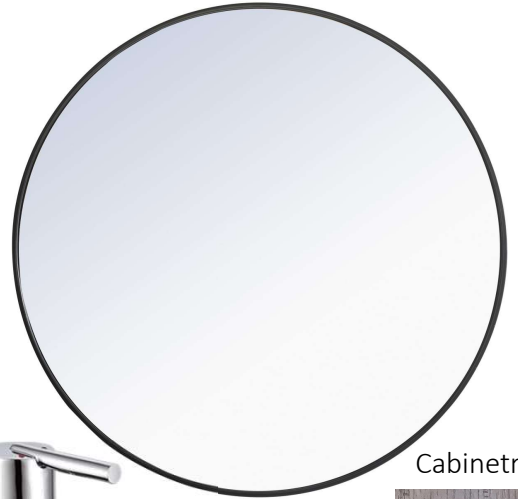

Cabinetry

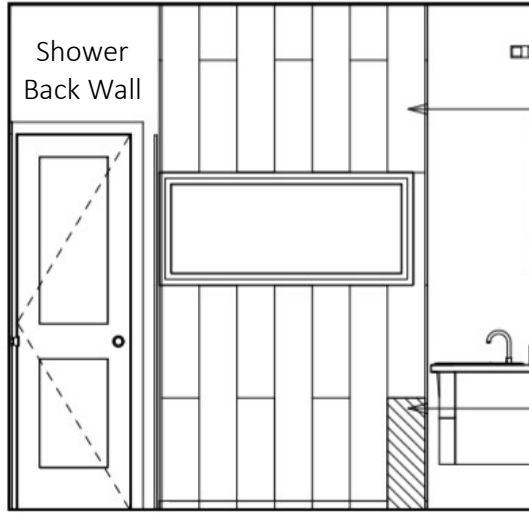

Shower Back Wall



ESTD / 1999

KIM LAYNE

interiors

GUEST BATH

Tub Walls
16x32, Straight Set

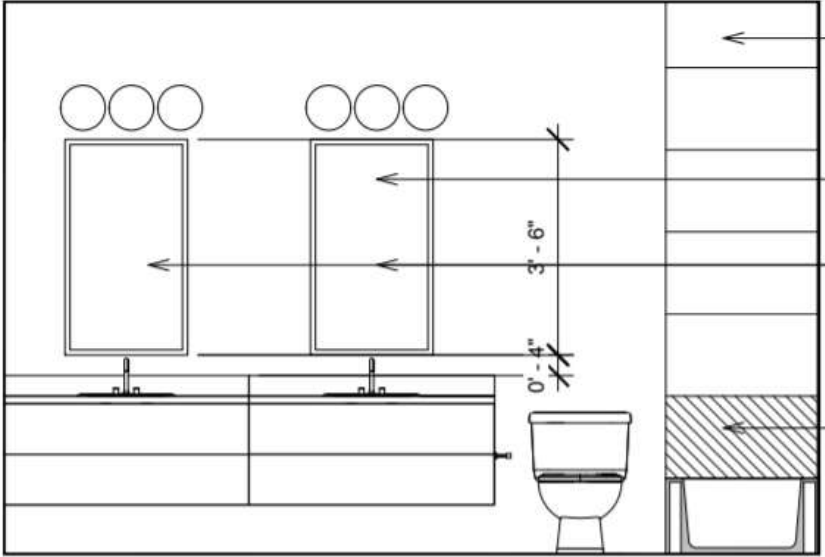

Floors
16x32, Straight Set

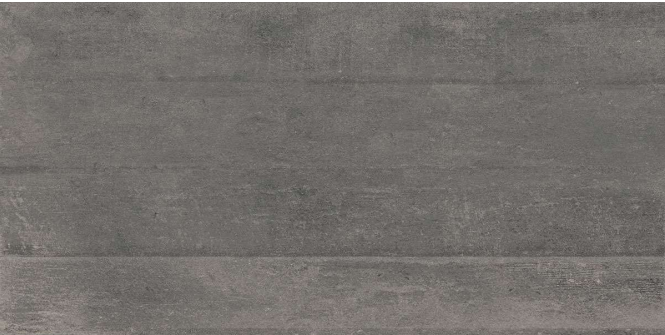

ESTD / 1999

KIM LAYNE

interiors

BASEMENT BATH BATH



ESTD / 1999

KIM LAYNE

interiors

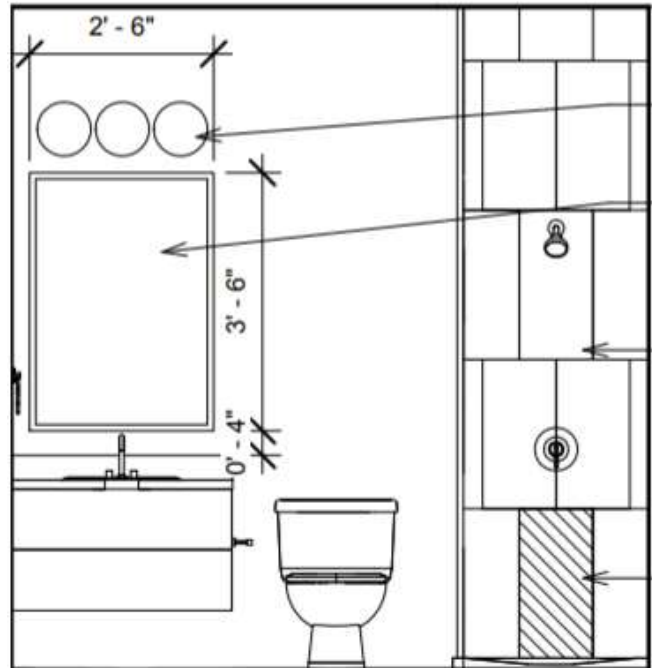

Shower Walls
12x24 Vertical
Brick Set



Shower Floor
2x2 mosaic



Floors
24x24, Straight Set

