

CURTICE STREET RESIDENCES  
WEST BUILDING – LIGHT PACKAGE



ESTD / 1999

KIM LAYNE

interiors

Single panel interior doors  
painted gray



Door Hardware



## INTERIOR FINISHES

Hardwoods  
Site finished white oak



Carpet



Base + case  
SW7005 Pure White

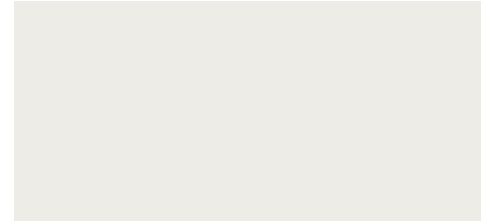

Walls  
SW7004 Snowbound

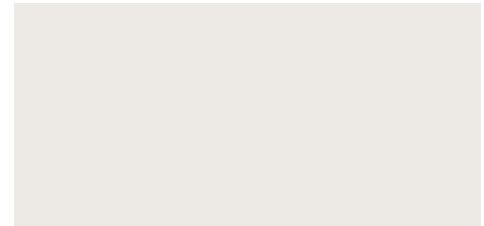

Doors  
SW7016 Mindful Gray



ESTD / 1999

KIM LAYNE

interiors

CONCEPTUAL IMAGES

Powder Bath Wainscoting



Master Bedroom Accent Wall



Powder wainscoting +  
Master accent wall  
SW7018 Dove Tail

ESTD / 1999

KIM LAYNE

interiors

KITCHEN

Backsplash

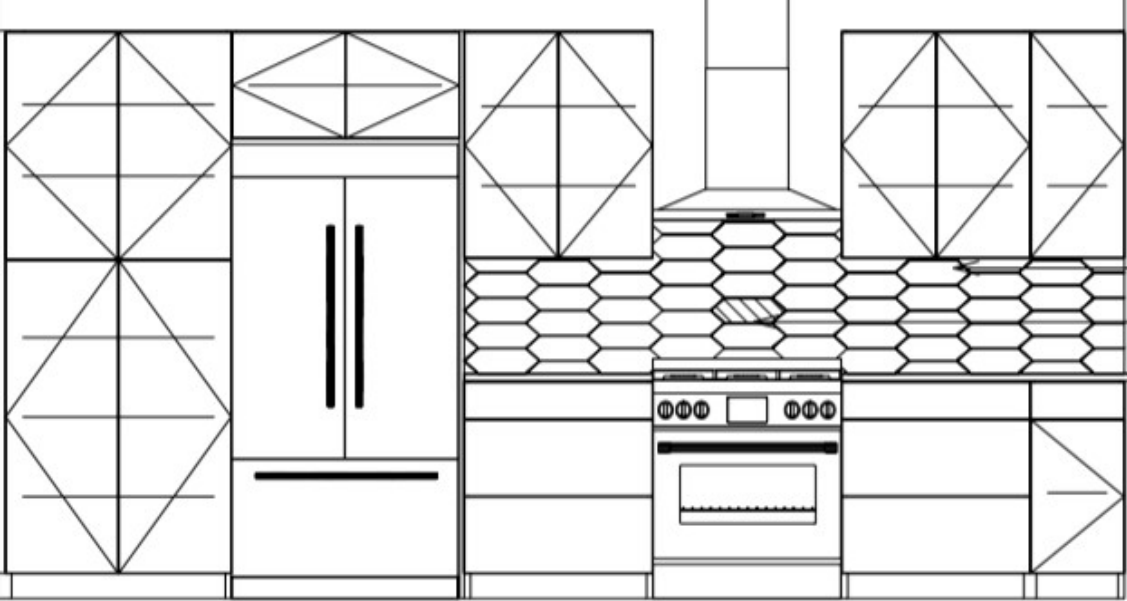

Kitchen Pendants



Cabinetry



Dining Light



ESTD / 1999

KIM LAYNE

interiors

OWNER'S ENTRY + POWDER BATH

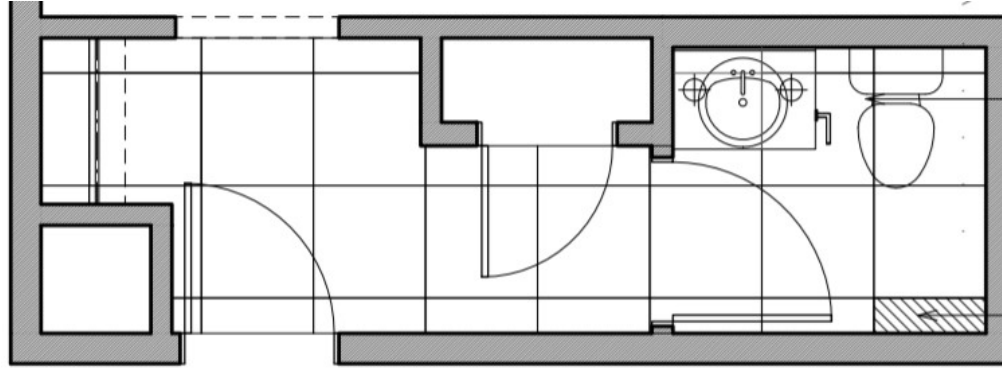

Cabinetry

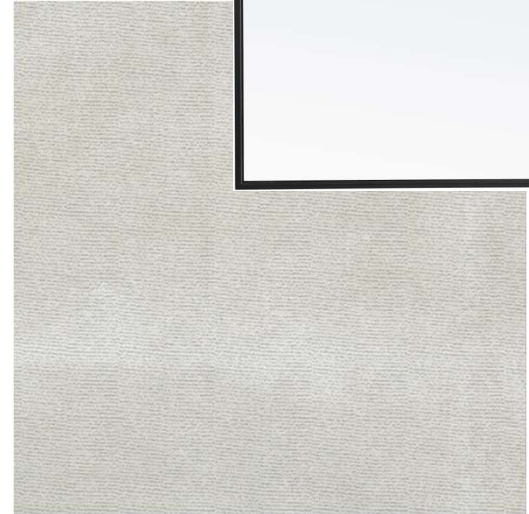
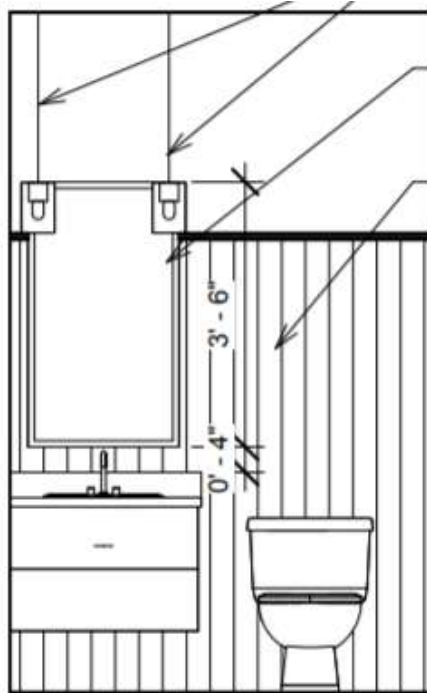
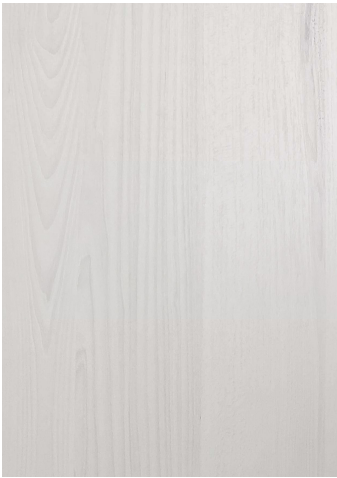

ESTD / 1999

KIM LAYNE

interiors



MASTER BATH

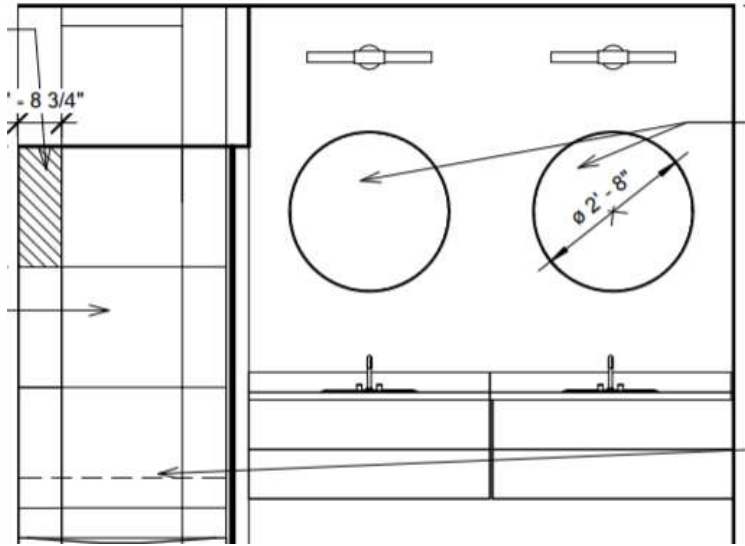

Floors + Shower Back Wall



Shower Side Walls 24x24, straight set



Shower Floor 2x2 mosaic



32\"/>



Cabinetry

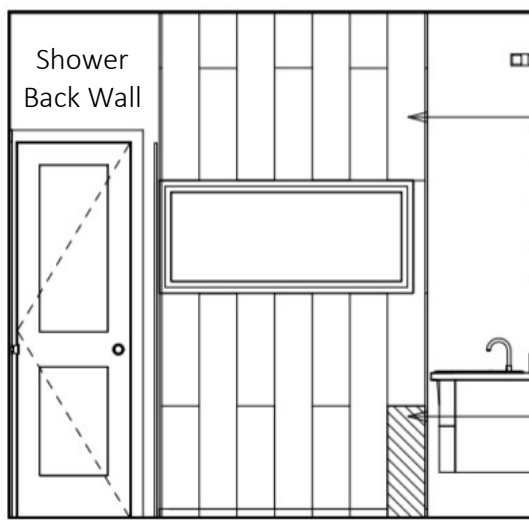
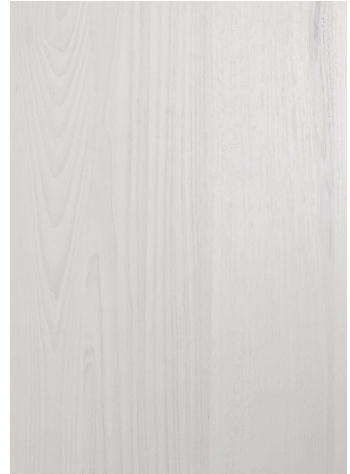

Shower Back Wall



ESTD / 1999

KIM LAYNE

interiors

GUEST BATH

Tub Walls  
16x32, Straight Set

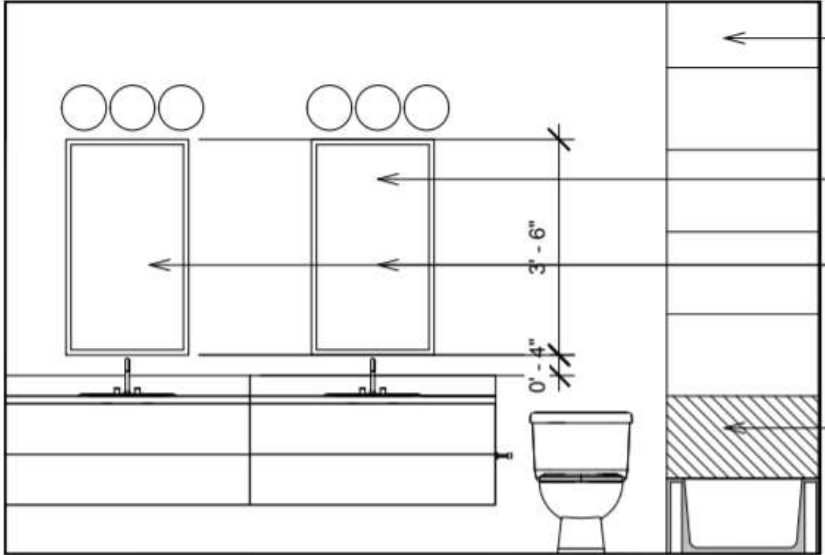

Cabinetry



Floors  
16x32, Straight Set

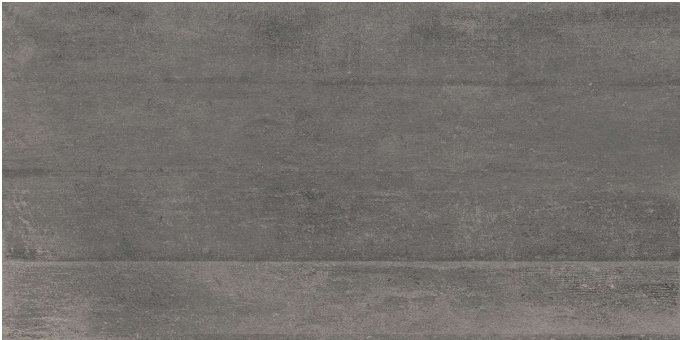

ESTD / 1999

KIM LAYNE

interiors

BASEMENT BATH



Cabinetry

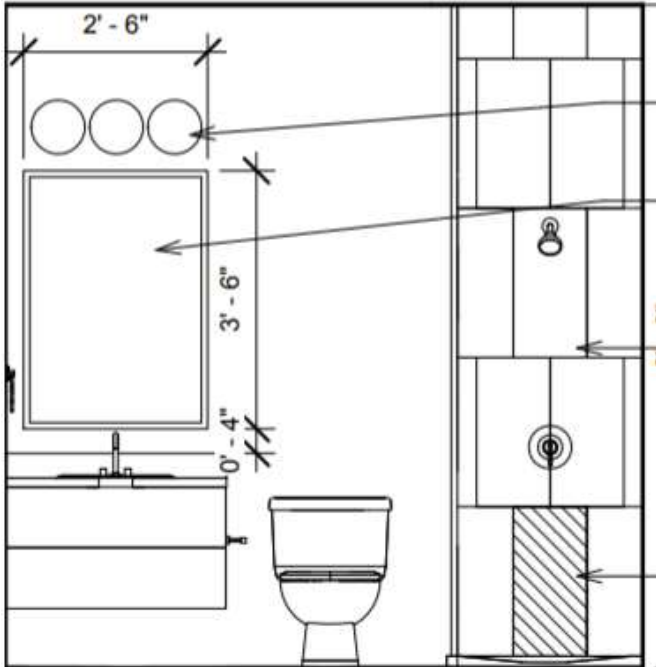

Shower Walls  
12x24 Vertical  
Brick Set



Shower Floor  
2x2 mosaic



Floors  
24x24, Straight Set

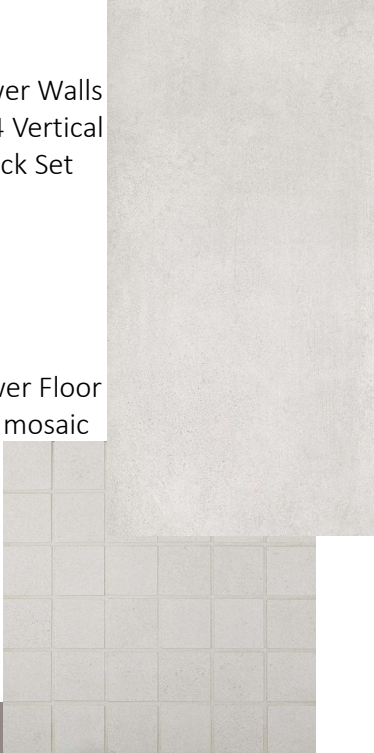

ESTD / 1999

KIM LAYNE

interiors